

SG05 PRO Autopilot Computer

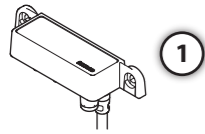

1

Parts included with SG05 PRO (000-11479-001)

- 1 SG05 PRO Autopilot computer
- 2 SG05 Fixing screws
- 3 Micro-C T-Joiner
- 4 SimNet to Micro-C (male) Drop Cable

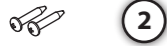

2

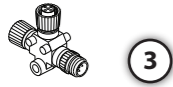

3



4

Parts included in SG05 PRO AC80A Kit (000-11483-001) and in SG05 PRO AC80S Kit (000-11483-001)

- 1 SG05 PRO Autopilot computer
- 2 SG05 Fixing screws
- 3 Micro-C T-Joiner
- 4 SimNet to Micro-C (male) Drop Cable
- 5 AC80S or AC80A Computer with accessories

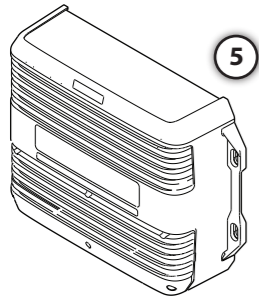

5

Used with the following Autopilot Control units

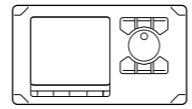

AP70

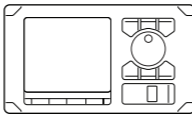

AP80

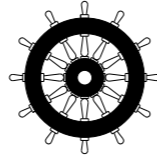

NOTE

SG05 PRO is Wheelmark approved when used in an AP70 or AP80 Wheelmark approved system.

PRO
SERIES

SIMRAD

SG05 AUTOPILOT COMPUTERS

INSTALLATION GUIDE

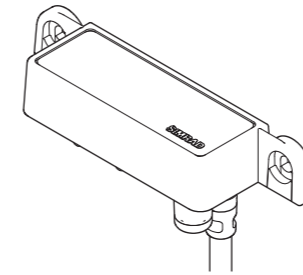

Dimensions

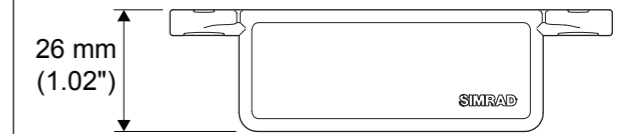
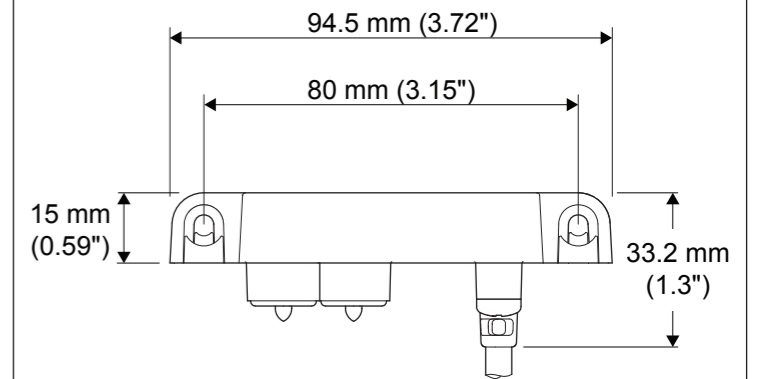

SG05 PRO - Wiring example

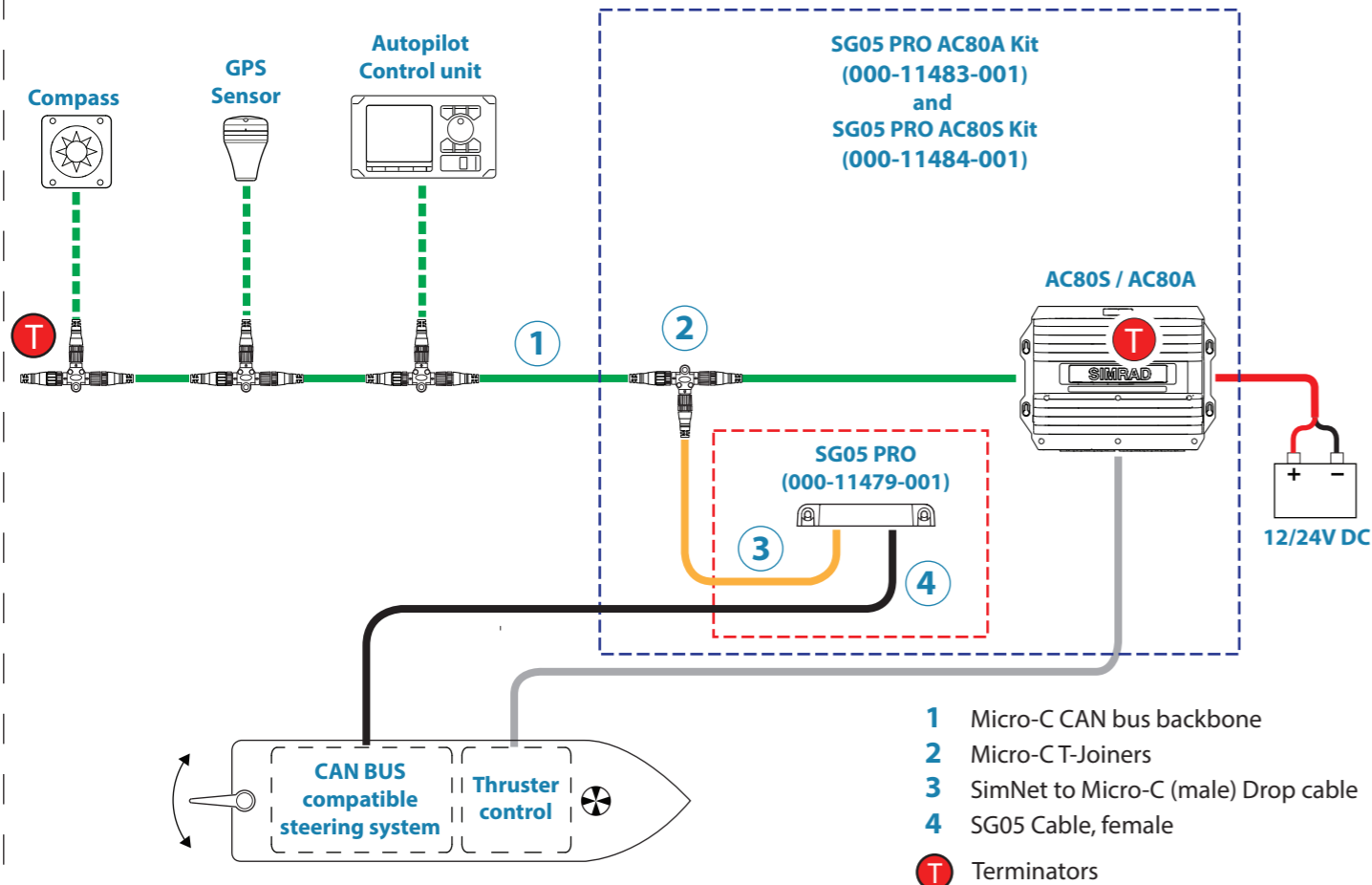

For technical specifications, certificates and declarations, refer to the product web site on:



pro.simrad-yachting.com



www.simrad-yachting.com



Mounting

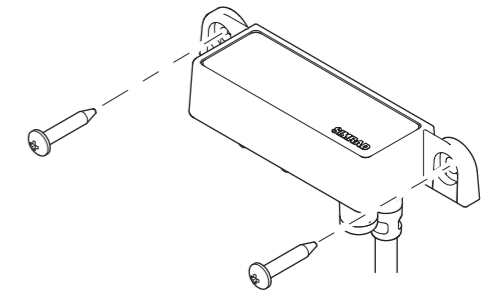

Connectors

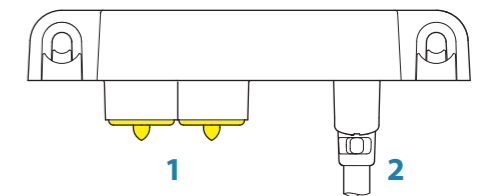

- 1 SimNet connectors (to backbone)
- 2 To Autopilot Gateway/Steering system

SG05 Autopilot Computer for Volvo/Yamaha

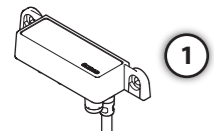

1

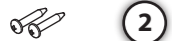

2

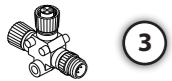

3



4

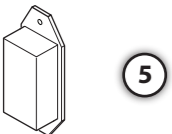

5

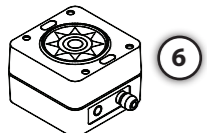

6

Parts included with
SG05 Volvo Autopilot computer
and with
Yamaha Autopilot computer
(24006793)

- 1 SG05 Volvo or Yamana Autopilot computer
- 2 SG05 Fixing screws

Parts included in
SG05 Volvo AP Kit
(000-10402-001)
and in
SG05 Yamaha H/Master AP Kit
(000-11286-001)

- 1 SG05 Volvo or Yamana Autopilot computer
- 2 SG05 Fixing screws
- 3 Micro-C T-Joiner
- 4 SimNet to Micro-C (male) Drop Cable
- 5 Volvo or Yamaha Autopilot Gateway
- 6 RC42N Rate compass with accessories

Used with the following
Autopilot Control units



OP10



QS80



AP24



AP28

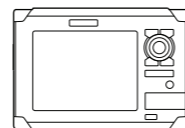

NSS
NSE
NSO/OP40

SG05 Autopilot Computer for Optimus/CAN bus

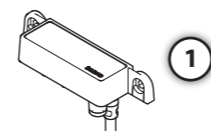

1



2

Parts included with
SG05 Optimus
(000-10906-001)

- 1 SG05 Optimus Autopilot computer
- 2 SG05 Fixing screws

Used with the following
Autopilot Control units



OP10



QS80



AP24



AP28

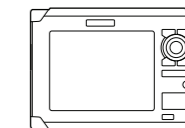

NSS
NSE
NSO/OP40

SG05 Volvo/Yamaha - Wiring example

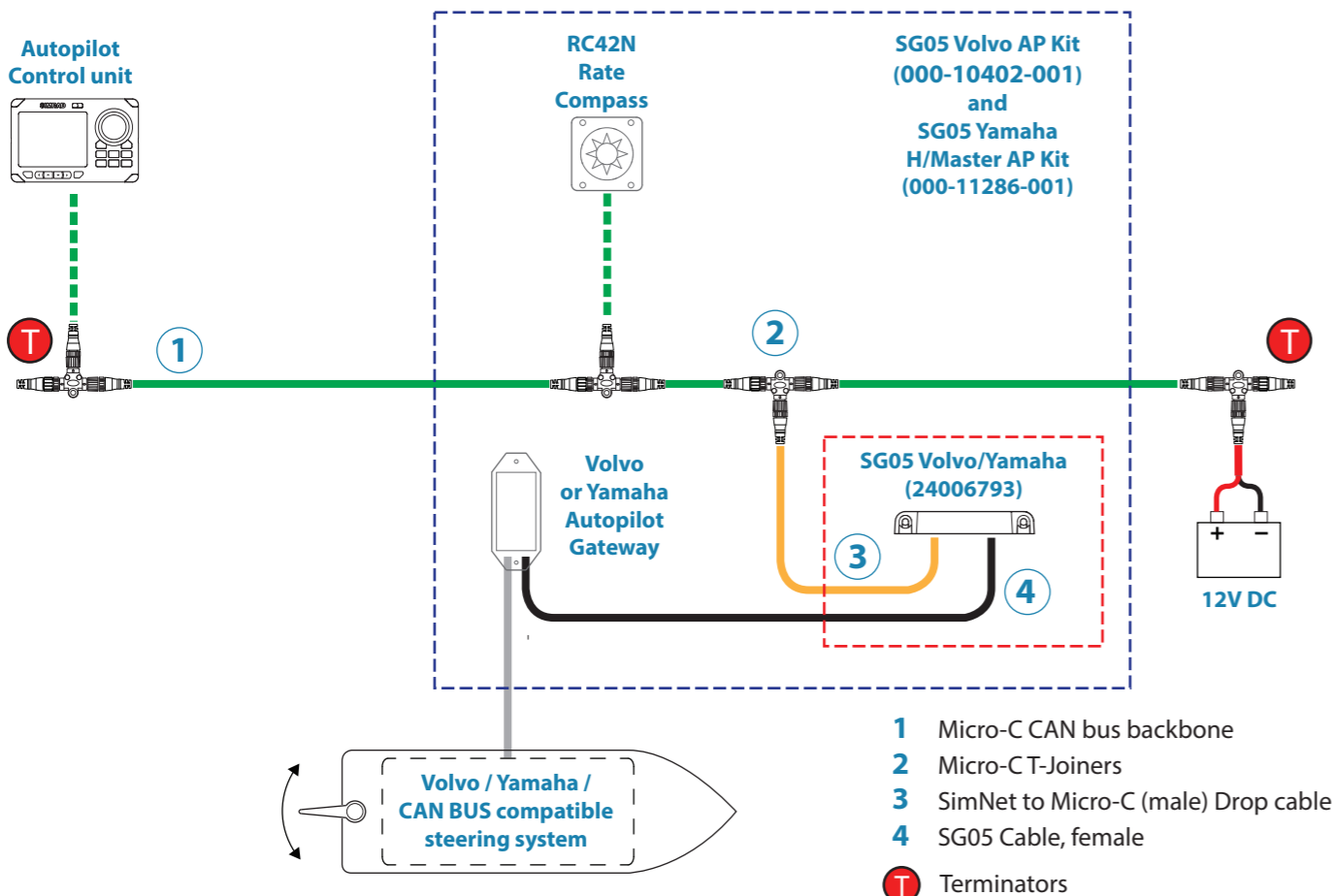

SG05 Optimus - Wiring example

